

Bus system flat-type plug - SACC-DSI-FSD-4CON-L180/SCO SH - 1553006

Please be informed that the data shown in this PDF Document is generated from our Online Catalog. Please find the complete data in the user's documentation. Our General Terms of Use for Downloads are valid (<http://phoenixcontact.com/download>)



Bus system flush-type socket, Ethernet and PROFINET, 4-pos., M12 SPEEDCON, shielded, D-coded, rear/screw mounting with Pg9 thread, with straight solder connection

Your advantages

- ✓ Easy PCB assembly: one-piece connectors for wave soldering
- ✓ All standard pin assignments and codings for signal, data, and power transmission with a uniform design-in design
- ✓ SPEEDCON fast locking system reduces cabling times
- ✓ For high transmission reliability: optional shield connection to the housing by means of shield contact



Ethernet



Key Commercial Data

Packing unit	1 pc
Minimum order quantity	20 pc
GTIN	 4 046356 162180
GTIN	4046356162180
Weight per Piece (excluding packing)	13.000 g
Custom tariff number	85366990
Country of origin	Germany

Technical data

Dimensions

Length of the solder pin	6 mm
--------------------------	------

Ambient conditions

Ambient temperature (operation)	-25 °C ... 85 °C
	-40 °C ... 85 °C (without mechanical actuation)

Bus system flat-type plug - SACC-DSI-FSD-4CON-L180/SCO SH - 1553006

Technical data

Ambient conditions

	-25 °C ... 85 °C
Degree of protection	IP67 (When plugged in)
	IP65 (When plugged in)

General

Note	The electrical and mechanical data specified assume that the connector pair is correctly locked and mounted. If the connector is unlocked and if there is a danger of contamination, the connector must be sealed using a protective cap > IP54. Influences arising from litz wires, cables or PCB assembly must also be taken into consideration.
Rated current at 40°C	4 A
Rated voltage	250 V
Rated surge voltage	2.5 kV
Number of positions	4
Insulation resistance	≥ 100 MΩ
Coding	D - data
Standards/regulations	M12 connector IEC 61076-2-101
Signal type/category	Ethernet
Status display	No
Overvoltage category	II
Degree of pollution	3
Connection method	Solder pins
Insertion/withdrawal cycles	> 100
Torque	2 Nm ... 3 Nm (Installation-side)
Mounting type	Rear mounting Pg9 With flat nut
Thread type	Pg9

Material

Flammability rating according to UL 94	V0
Contact material	CuZn
Contact surface material	Ni/Au
Contact carrier material	PA 6.6
Material, knurls	Zinc die-cast, nickel-plated
Sealing material	FKM

Standards and Regulations

Standards/specifications	M12 connector IEC 61076-2-101
Flammability rating according to UL 94	V0

Environmental Product Compliance

REACH SVHC	Lead 7439-92-1
------------	----------------

Bus system flat-type plug - SACC-DSI-FSD-4CON-L180/SCO SH - 1553006

Technical data

Environmental Product Compliance

China RoHS	Environmentally Friendly Use Period = 50 years
	For details about hazardous substances go to tab "Downloads", Category "Manufacturer's declaration"

Drawings

Dimensional drawing

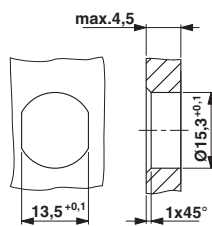

Schematic diagram

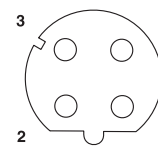

Pin assignment M12 socket, 4-pos., D-coded, female side

Housing cutout for Pg9 fastening thread, mounting panel with feed-through hole (alternatively with area as anti-rotation protection for panel thicknesses > 2 mm up to max. 4.5 mm)

Dimensional drawing

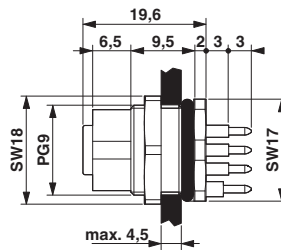

Drilling diagram

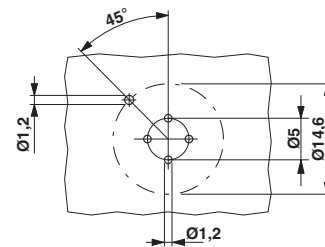

M12 flush-type connector

Bus system flat-type plug - SACC-DSI-FSD-4CON-L180/SCO SH - 1553006

Dimensional drawing

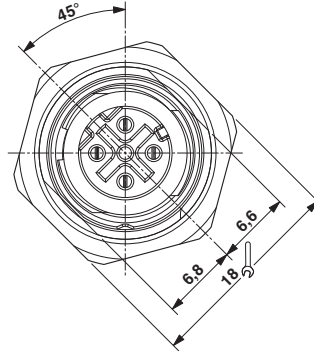

M12 front view

Classifications

eCl@ss

eCl@ss 10.0.1	27440102
eCl@ss 11.0	27440102
eCl@ss 4.0	27140800
eCl@ss 4.1	27140800
eCl@ss 5.0	27143400
eCl@ss 5.1	27143400
eCl@ss 6.0	27279200
eCl@ss 7.0	27440103
eCl@ss 9.0	27440102

ETIM

ETIM 3.0	EC002061
ETIM 4.0	EC000830
ETIM 6.0	EC002061

UNSPSC

UNSPSC 6.01	31261501
UNSPSC 7.0901	31261501
UNSPSC 11	31261501
UNSPSC 12.01	31261501
UNSPSC 13.2	39121413
UNSPSC 18.0	39121413
UNSPSC 19.0	39121413
UNSPSC 20.0	39121413

Bus system flat-type plug - SACC-DSI-FSD-4CON-L180/SCO SH - 1553006

Classifications

UNSPSC

UNSPSC 21.0	39121413
-------------	----------

Approvals

Approvals

Approvals

UL Recognized / EAC / cULus Recognized

Ex Approvals

Approval details

UL Recognized		http://database.ul.com/cgi-bin/XYV/template/LISEXT/1FRAME/index.htm	FILE E 118976
Nominal voltage UN		250 V	
Nominal current IN		4 A	
mm ² /AWG/kcmil		22	

EAC		B.01687
-----	---	---------

cULus Recognized		http://database.ul.com/cgi-bin/XYV/template/LISEXT/1FRAME/index.htm	E221474-20140616
Nominal voltage UN		250 V	
Nominal current IN		4 A	
mm ² /AWG/kcmil		22-20	

Accessories

Accessories

Plug for cable screw gland

Bus system flat-type plug - SACC-DSI-FSD-4CON-L180/SCO SH - 1553006

Accessories

Screw plug - PROT-M12 - 1680539



An M12 screw plug for the unoccupied M12 sockets of the sensor/actuator cable, boxes and flush-type connectors

Screw plug - PROT-M12 SH - 1503302



An M12 screw plug for the unoccupied M12 sockets of the shielded sensor/actuator cable, boxes and flush-type connectors

Screw plug - PROT-M12 FB - 1555538



M12 high-grade steel screw plug, for unoccupied M12 sockets of the sensor/actuator cables, boxes and flush-type connectors for the food industry

Seal

Flat gasket - SACC-PG9-SEAL CLM - 1556320



Pg9 flat gasket for the rear mounting of M12 flush-type connectors with Pg9 fastening threads
